

FEATURES

- Single-supply operation: 4.5 V to 18 V
- Upper/lower buffers swing to V_S /GND
- Gamma continuous output current: >10 mA
- V_{COM} peak output current: 250 mA
- Offset voltage: 12 mV
- Slew rate: 8 V/ μ s
- Unity gain stable with large capacitive loads
- Supply current: 700 μ A per amplifier
- Compact 28-lead TSSOP
- Pb-free package
- Drop-in replacement for BUF11702

APPLICATIONS

- TFT LCD monitor panels
- TFT LCD notebook panels

GENERAL DESCRIPTION

The ADD8710 is a low cost, 10-channel gamma buffer with a V_{COM} driver that operates from a single supply. The part is designed for high resolution TFT LCD panels and is built on an advanced, high voltage CBCMOS process.

The gamma buffers have a high slew rate, minimum 10 mA output current, and a high capacitive load drive capability. The V_{COM} buffer is capable of delivering 250 mA of peak current and can also drive large capacitive loads. The ADD8710 offers a wide supply range and offset voltages below 12 mV.

The ADD8710 is specified over the -40°C to $+85^{\circ}\text{C}$ temperature range and is available in a Pb-free, 28-lead TSSOP package.

PIN CONFIGURATION

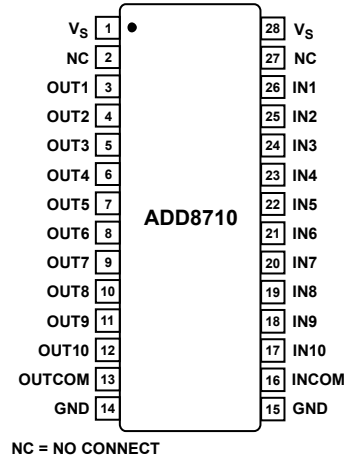

Figure 1. 28-Lead TSSOP (RU Suffix)

FUNCTIONAL BLOCK DIAGRAM

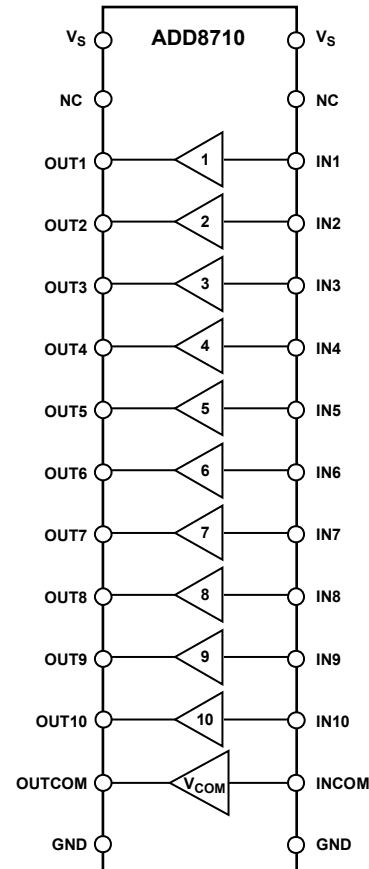

Figure 2.

Rev. B

Information furnished by Analog Devices is believed to be accurate and reliable. However, no responsibility is assumed by Analog Devices for its use, nor for any infringements of patents or other rights of third parties that may result from its use. Specifications subject to change without notice. No license is granted by implication or otherwise under any patent or patent rights of Analog Devices. Trademarks and registered trademarks are the property of their respective owners.

TABLE OF CONTENTS

Features	1	Absolute Maximum Ratings	4
Applications.....	1	Thermal Resistance	4
General Description	1	ESD Caution.....	4
Pin Configuration.....	1	Typical Performance Characteristics	5
Functional Block Diagram	1	Outline Dimensions	10
Revision History	2	Ordering Guide	10
Specifications.....	3		

REVISION HISTORY

6/07—Rev. A to Rev. B

Changes to Figure 18.....	7
---------------------------	---

3/05—Rev. 0 to Rev. A

Change to Features	1
Changes to Specifications	3
Change to Absolute Maximum Ratings.....	4

6/04—Revision 0: Initial Version

SPECIFICATIONS

$V_S = 16\text{ V}$, $V_{CM} = V_S/2$, $T_A @ 25^\circ\text{C}$, unless otherwise noted.

Table 1.

Parameter	Symbol	Condition	Min	Typ	Max	Unit
INPUT CHARACTERISTICS						
Offset Voltage	V_{OS}	Applies to all channels		4	12	mV
Offset Voltage Drift	$\Delta V_{OS}/\Delta T$	$-40^\circ\text{C} \leq T_A \leq +85^\circ\text{C}$		5		$\mu\text{V}/^\circ\text{C}$
Input Bias Current	I_B	$-40^\circ\text{C} \leq T_A \leq +85^\circ\text{C}$		0.5	1.1	μA
Input Impedance	Z_{IN}			400	1.5	k Ω
Input Capacitance	C_{IN}			1		pF
BUFFER CHARACTERISTICS						
Common-Mode Input Range	V_{CMM}		1.25		V_S	V
Buffer 1 to Buffer 5			0		$V_S - 1.25$	V
Buffer 6 to Buffer 10						V
Output Voltage High (V1)	V_{OH}	$V_S = 16\text{ V}$, $V_{IN} = 16\text{ V}$, $I_L = 10\text{ mA}$ $V_S = 10\text{ V}$, $V_{IN} = 9.8\text{ V}$, $I_L = 10\text{ mA}$ $-40^\circ\text{C} \leq T_A \leq +85^\circ\text{C}$	15.82	15.9		V
Output Voltage High (V2 to V5)	V_{OH}	$V_S = 10\text{ V}$, $V_{IN} = 8.5\text{ V}$, $I_L = 10\text{ mA}$ $-40^\circ\text{C} \leq T_A \leq +85^\circ\text{C}$	9.75	9.8		V
Output Voltage High (V6 to V10)	V_{OH}	$V_S = 10\text{ V}$, $V_{IN} = 8\text{ V}$, $I_L = 10\text{ mA}$ $-40^\circ\text{C} \leq T_A \leq +85^\circ\text{C}$	9.7	8.5		V
Output Voltage Low (V1 to V5)	V_{OL}	$V_S = 10\text{ V}$, $V_{IN} = 2\text{ V}$, $I_L = 10\text{ mA}$ $-40^\circ\text{C} \leq T_A \leq +85^\circ\text{C}$	8.45	8	2.05	V
Output Voltage Low (V6 to V9)	V_{OL}	$V_S = 10\text{ V}$, $V_{IN} = 1.5\text{ V}$, $I_L = 10\text{ mA}$ $-40^\circ\text{C} \leq T_A \leq +85^\circ\text{C}$	8.4		2.10	V
Output Voltage Low (V10)	V_{OL}	$V_S = 16\text{ V}$, $V_{IN} = 0\text{ V}$, $I_L = 10\text{ mA}$ $V_S = 10\text{ V}$, $V_{IN} = 0.2\text{ V}$, $I_L = 10\text{ mA}$ $-40^\circ\text{C} \leq T_A \leq +85^\circ\text{C}$	7.95	8	1.55	V
Continuous Output Current	I_{OUT}		7.9		1.60	V
Peak Output Current	I_{PK}	$V_S = 16\text{ V}$		0.1	0.175	V
Continuous Output Current	I_{OUT}			0.2	0.25	V
Peak Output Current	I_{PK}			0.3		V
Continuous Output Current	I_{OUT}			10		mA
Peak Output Current	I_{PK}			100		mA
V_{COM} CHARACTERISTICS						
Common-Mode Input Range	V_{CMM}		0		$V_S - 1.25$	V
Output Voltage High	V_{OH}	$V_S = 10\text{ V}$, $V_{IN} = 8\text{ V}$, $I_L = 30\text{ mA}$ $-40^\circ\text{C} \leq T_A \leq +85^\circ\text{C}$	7.95	8		V
Output Voltage Low	V_{OL}	$V_S = 10\text{ V}$, $V_{IN} = 2\text{ V}$, $I_L = 30\text{ mA}$ $-40^\circ\text{C} \leq T_A \leq +85^\circ\text{C}$	7.9			V
Continuous Output Current	I_{OUT}			2	2.05	V
Peak Output Current	I_{PK}			250	2.10	V
SUPPLY CHARACTERISTICS						
Supply Voltage	V_S		4.5		18	V
Power Supply Rejection Ratio	PSRR	$V_S = 4.5\text{ V to } 16.5\text{ V}$, $-40^\circ\text{C} \leq T_A \leq +85^\circ\text{C}$	70	90		dB
Total Supply Current	I_{SY}	$V_O = V_S/2$, no load $-40^\circ\text{C} \leq T_A \leq +85^\circ\text{C}$		7.7	10	mA
DYNAMIC PERFORMANCE						
Slew Rate	SR	$R_L = 2\text{ k}\Omega$, $C_L = 200\text{ pF}$	4	8		V/ μs
Bandwidth	BW	-3 dB , $R_L = 10\text{ k}\Omega$, $C_L = 200\text{ pF}$		5		MHz
Settling Time to 0.1% (Buffers)	t_s	1 V step, $R_L = 10\text{ k}\Omega$, $C_L = 200\text{ pF}$		1.1		μs
Settling Time to 0.1% (V_{COM})	t_s	1 V step, $R_L = 10\text{ k}\Omega$, $C_L = 200\text{ pF}$		0.7		μs
Phase Margin	Φ_O	$R_L = 10\text{ k}\Omega$, $C_L = 200\text{ pF}$		45		Degrees
Channel Separation				75		dB

ABSOLUTE MAXIMUM RATINGS

Table 2.

Parameter	Rating
Supply Voltage (V _S)	18.5 V
Input Voltage	-0.5 V to V _S + 0.5 V
Storage Temperature Range	-65°C to +150°C
Operating Temperature Range	-40°C to +85°C
Junction Temperature Range	-65°C to +150°C
Lead Temperature	300°C
ESD Tolerance (HBM)	±2500 V
ESD Tolerance (MM)	±200 V

Stresses above those listed under Absolute Maximum Ratings may cause permanent damage to the device. This is a stress rating only; functional operation of the device at these or any other conditions above those indicated in the operational sections of this specification is not implied. Exposure to absolute maximum rating conditions for extended periods may affect device reliability.

THERMAL RESISTANCE

θ_{JA} is specified for the worst-case conditions, that is, a device soldered in a circuit board for surface-mount packages.

Table 3. Thermal Resistance

Package Type	θ_{JA}	Unit
28-Lead TSSOP (RU)	67.7	°C/W

ESD CAUTION



ESD (electrostatic discharge) sensitive device. Charged devices and circuit boards can discharge without detection. Although this product features patented or proprietary protection circuitry, damage may occur on devices subjected to high energy ESD. Therefore, proper ESD precautions should be taken to avoid performance degradation or loss of functionality.

TYPICAL PERFORMANCE CHARACTERISTICS

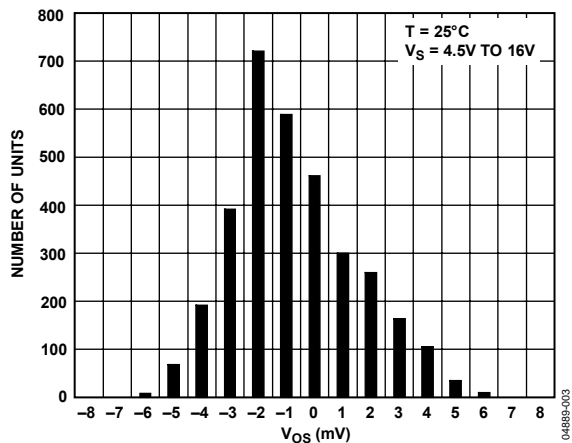

Figure 3. Input Offset Voltage Distribution

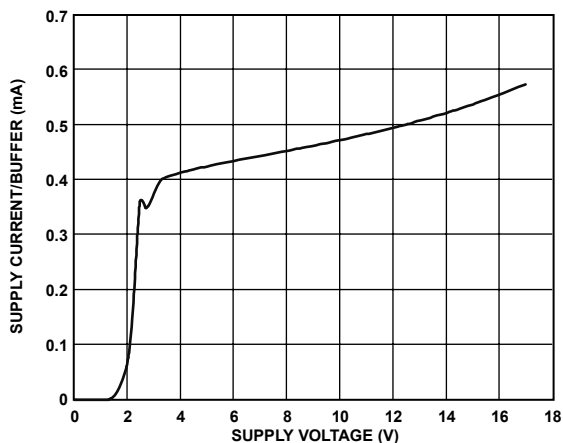

Figure 6. Supply Current/Buffer vs. Supply Voltage

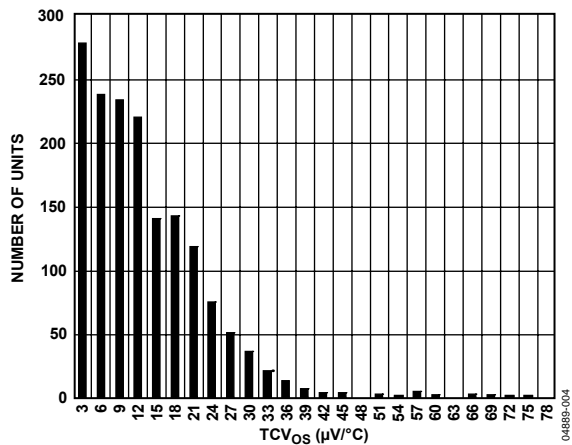

Figure 4. Input Offset Voltage Drift Distribution

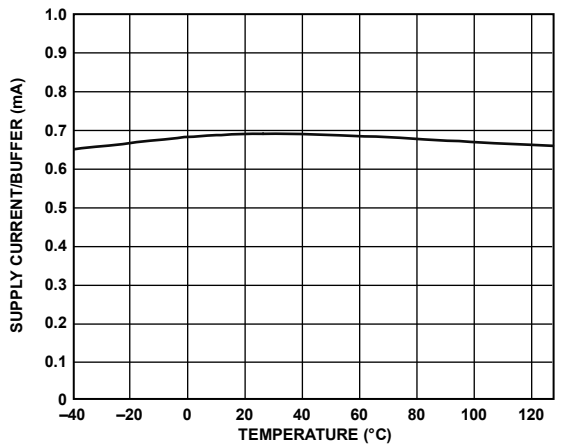

Figure 7. Supply Current/Buffer vs. Temperature

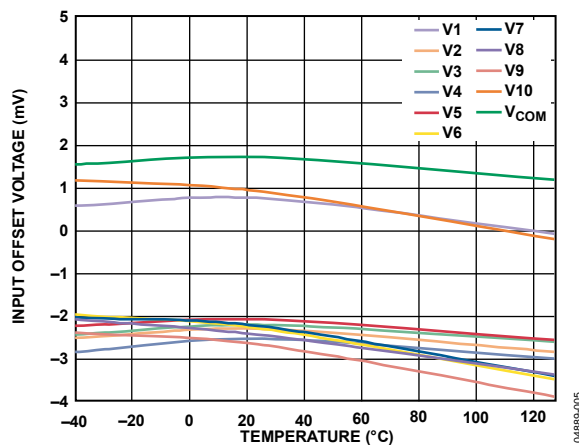

Figure 5. Input Offset Voltage vs. Temperature

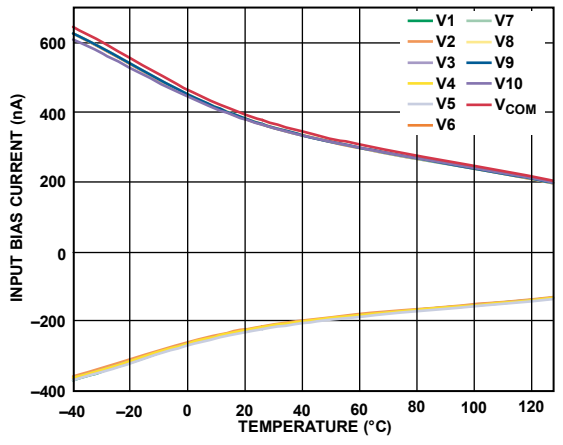

Figure 8. Input Bias Current vs. Temperature

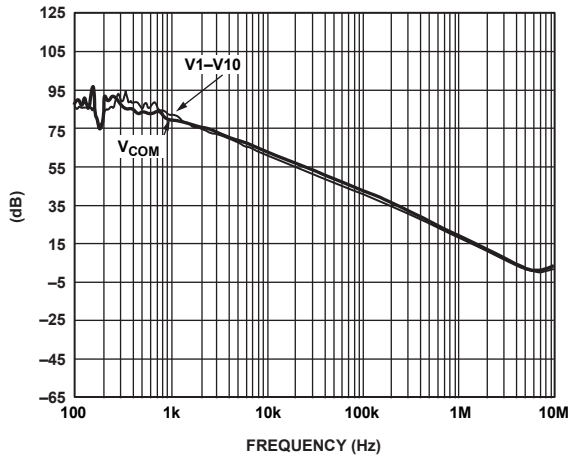

Figure 9. Power Supply Rejection Ratio vs. Frequency

04889-009

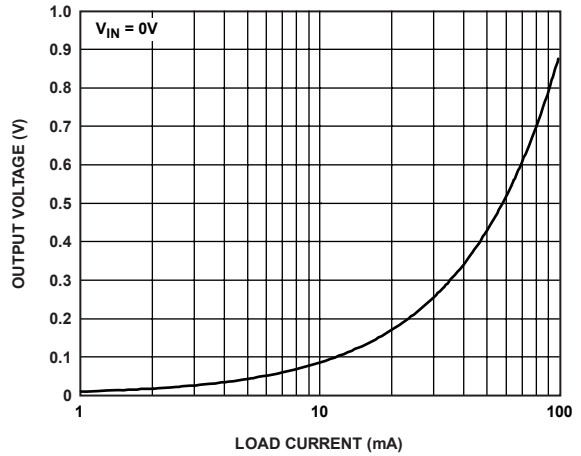

Figure 12. Channel V_{COM} Output Voltage Low vs. Load Current

04889-012

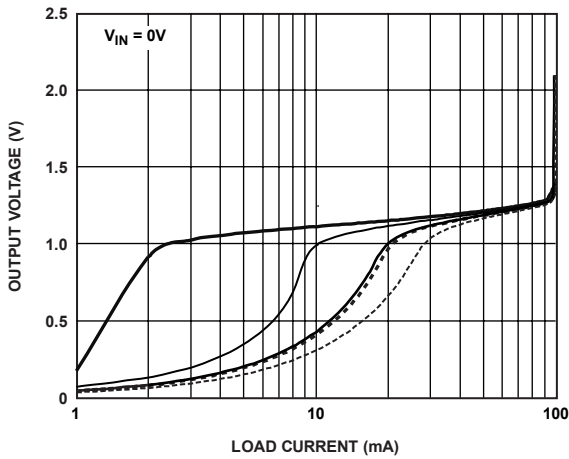

Figure 10. Channel 1 to Channel 5 Output Voltage Low vs. Load Current

04889-010

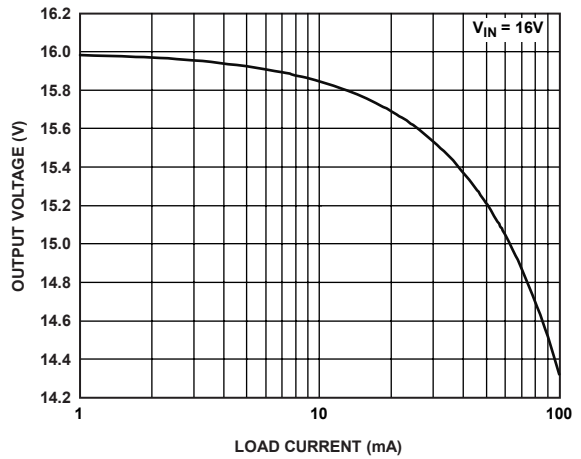

Figure 13. Channel 1 Output Voltage High vs. Load Current

04889-013

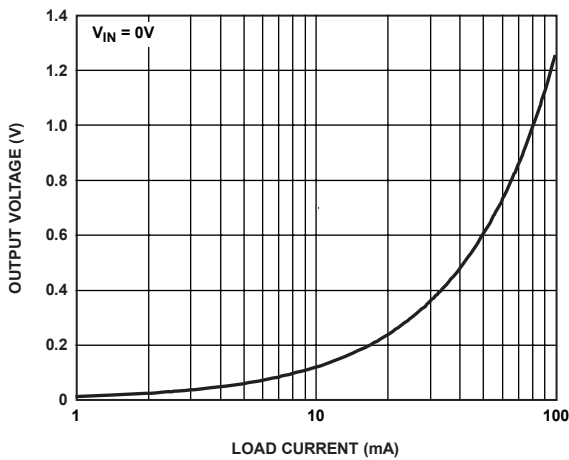

Figure 11. Channel 6 to Channel 10 Output Voltage Low vs. Load Current

04889-011

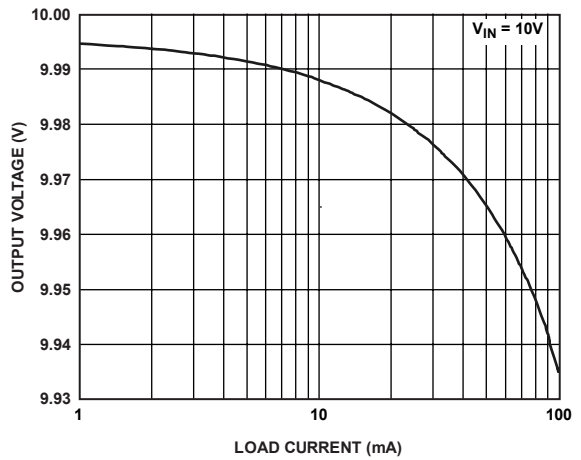

Figure 14. Channel 2 to Channel 5 Output Voltage High vs. Load Current

04889-014

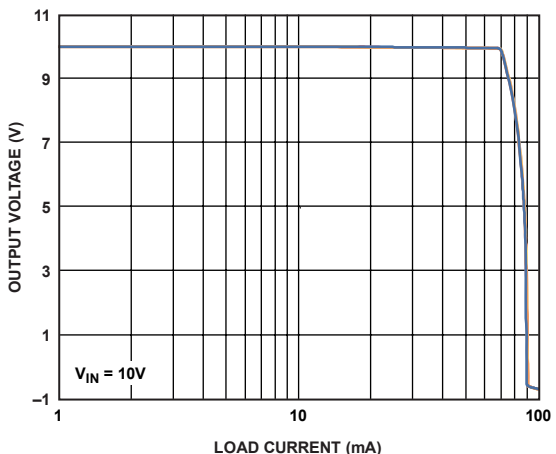

Figure 15. Channel 6 to Channel 10 Output Voltage High vs. Load Current

04889-015

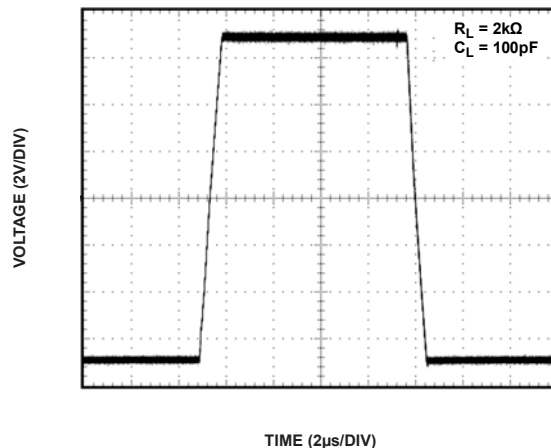

Figure 18. Large Signal Transient Response

04889-018

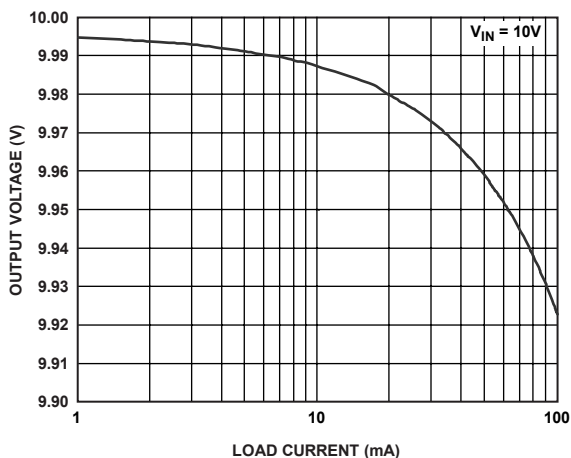

Figure 16. Channel V_{COM} Output Voltage High vs. Load Current

04889-016

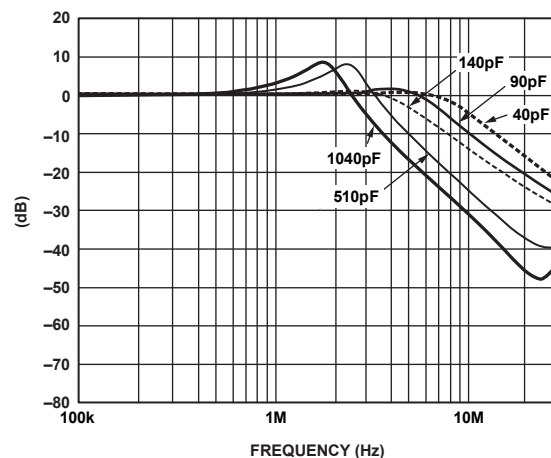

Figure 19. Channel 1 to Channel 5 Frequency Response vs. Capacitive Loading

04889-019

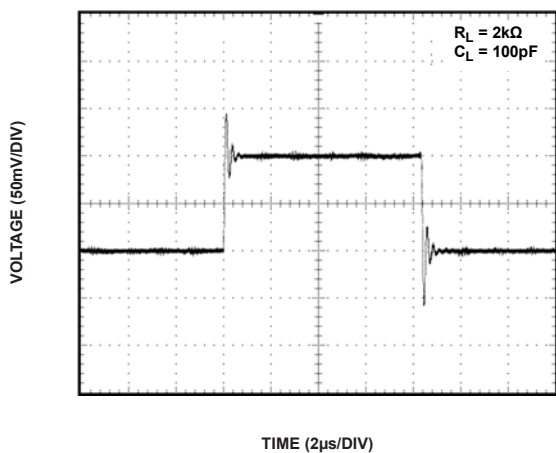

Figure 17. Small Signal Transient Response

04889-017

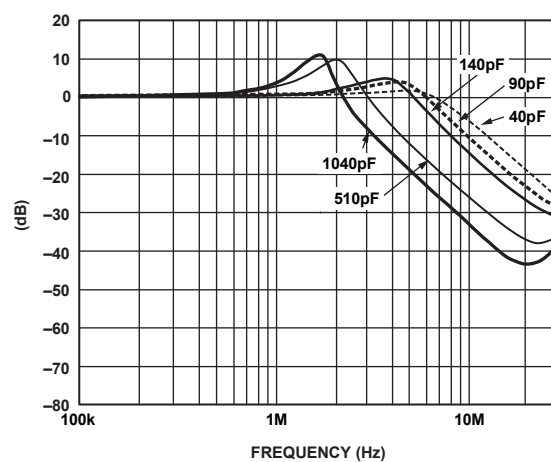

Figure 20. Channel 6 to Channel 10 Frequency Response vs. Capacitive Loading

04889-020

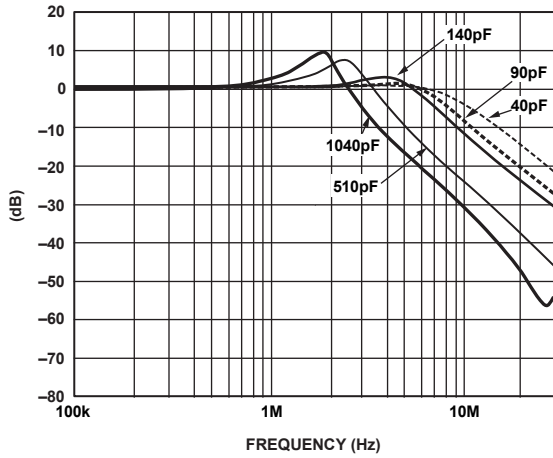

Figure 21. Channel V_{COM} Frequency Response vs. Capacitive Loading

04889-021

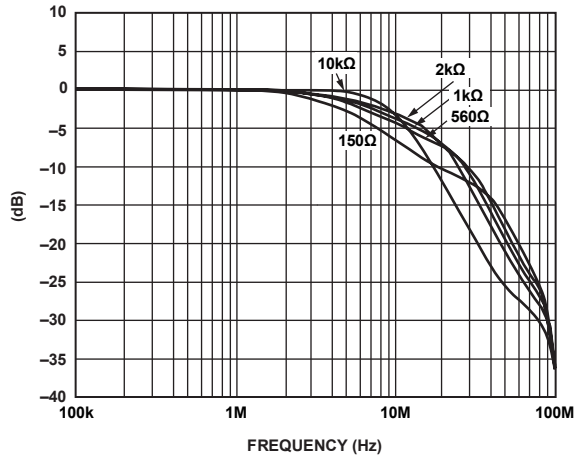

Figure 24. Channel V_{COM} Frequency Response vs. Resistive Loading

04889-024

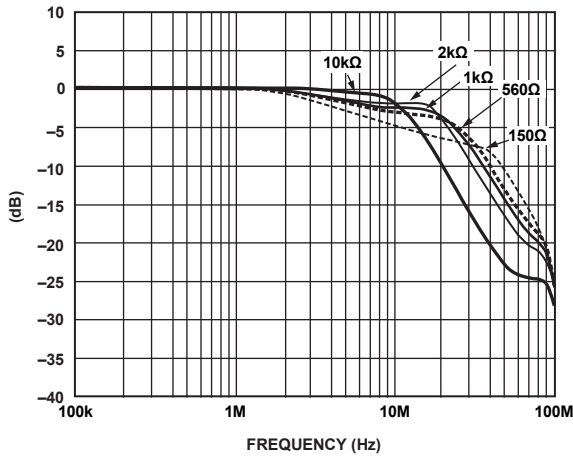

Figure 22. Channel 1 to Channel 5 Frequency Response vs. Resistive Loading

04889-022

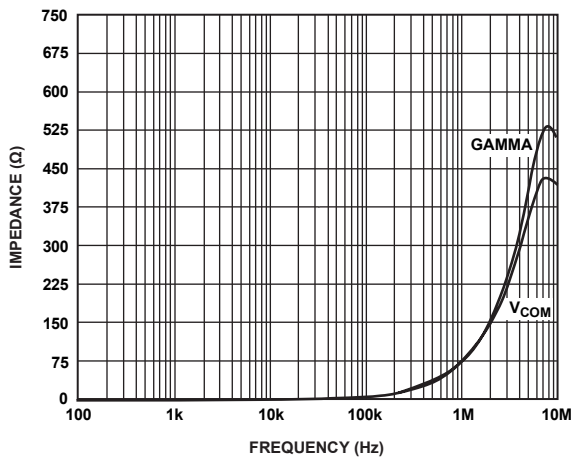

Figure 25. Closed-Loop Output Impedance vs. Frequency

04889-025

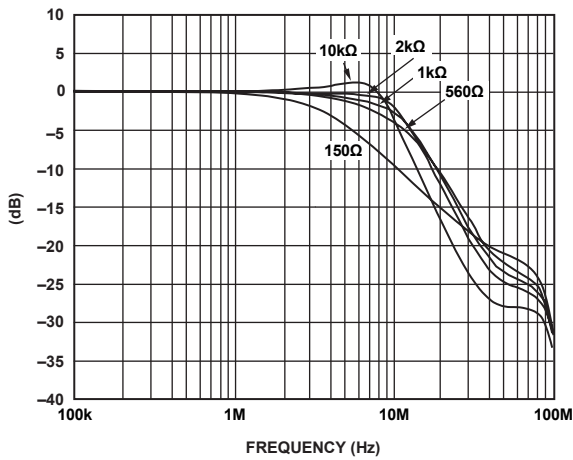

Figure 23. Channel 6 to Channel 10 Frequency Response vs. Resistive Loading

04889-023

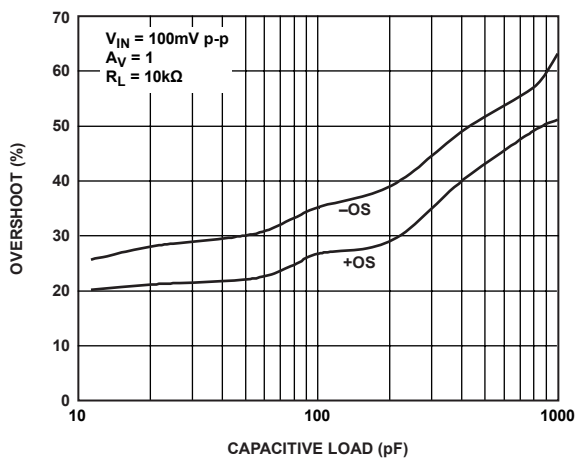
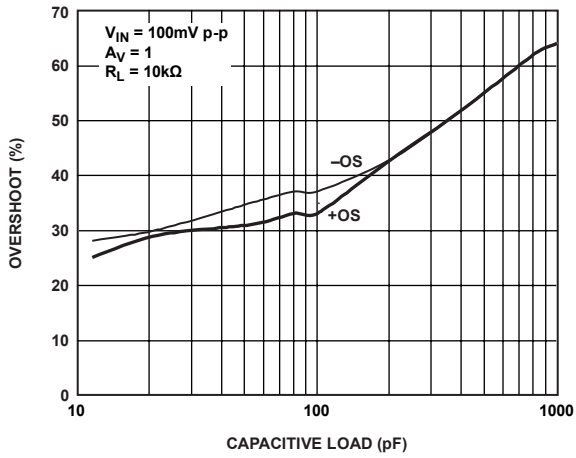

Figure 26. Channel 1 to Channel 5 Small Signal Overshoot vs. Load Capacitance

04889-026



04889-027

Figure 27. Channel 6 to Channel 10 Small Signal Overshoot vs. Load Capacitance

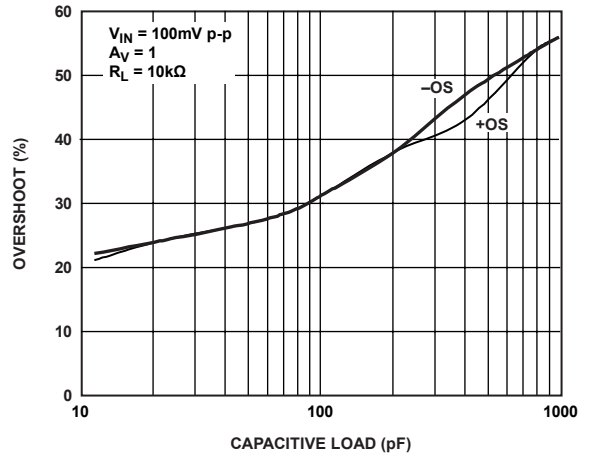

04889-028

Figure 28. Channel V_{COM} Small Signal Overshoot vs. Load Capacitance

ADD8710

OUTLINE DIMENSIONS

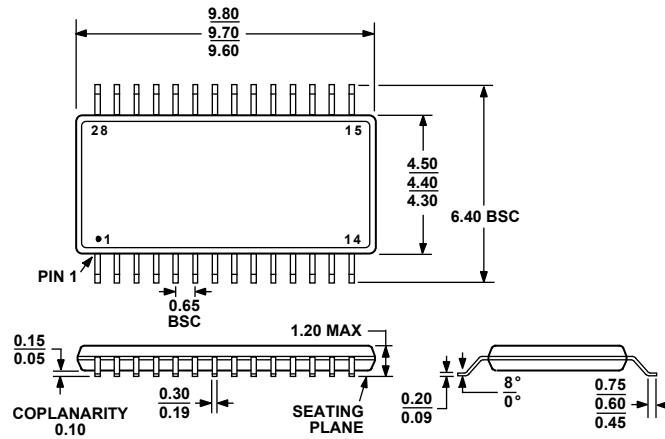

COMPLIANT TO JEDEC STANDARDS MO-153-AE

Figure 29. 28-Lead Thin Shrink Small Outline Package [TSSOP] (RU-28)

Dimensions shown in millimeters

ORDERING GUIDE

Model	Temperature Range	Package Description	Package Option
ADD8710ARUZ ¹	-40°C to +85°C	28-Lead TSSOP	RU-28
ADD8710ARUZ-REEL ¹	-40°C to +85°C	28-Lead TSSOP	RU-28

¹ Z = RoHS Compliant Part.

NOTES

ADD8710

NOTES